

apple  Lite

Let there be light

June 2022

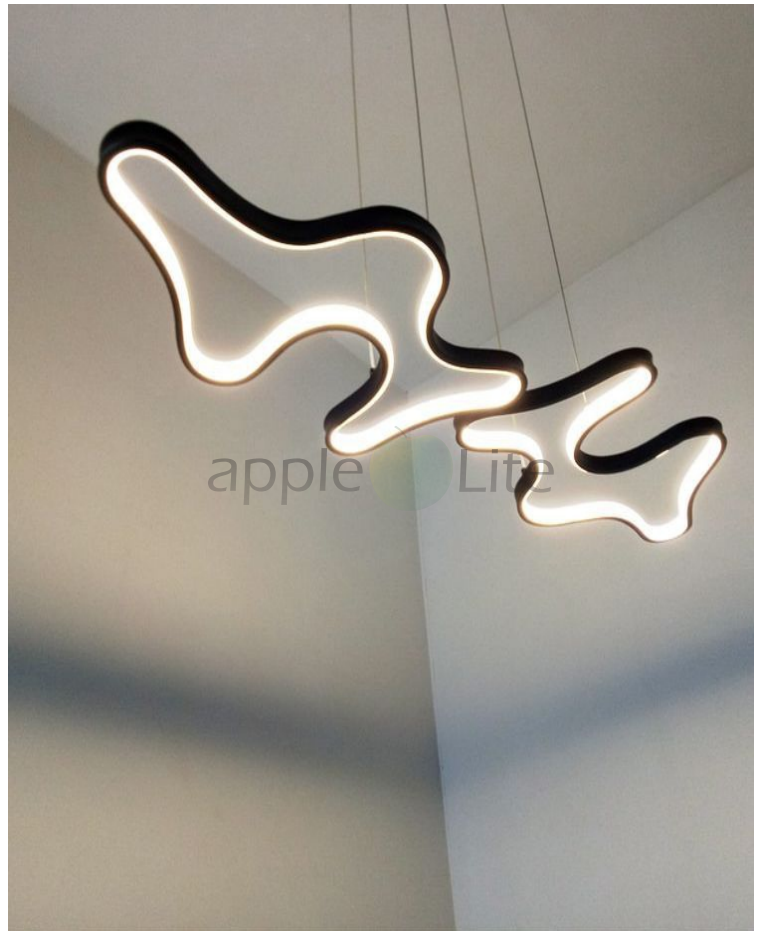

Product Code - **KI-D246**

Driver External
 Options : Out Light \ In Light
 Body Color : White \ Black \ Brown \ Gold \ Rose Gold
 Mounting : Hanging Length 1000mm.
 Can be customized to any size
 Housing Material : Aluminum Extruded & PC Cover.

Product Code - **KI-D246-A**

Driver External
 Options : Out Light \ In Light \ Partial Light
 Body Color : White \ Black \ Brown \ Gold \ Rose Gold
 Mounting : Hanging Length 1000mm.
 Can be customized to any size
 Housing Material : Aluminum Extruded & PC Cover.

Product Code	Profile Part	Watt	Color Temp.	Beam	CRI	Dimensions	MRP.
KI-D246	KISP01	16W	WW-NW-CW	120°	>80	1000x200mm	12320.00
KI-D246-A	KISP01	24W	WW-NW-CW	120°	>80	1200x400mm	24640.00

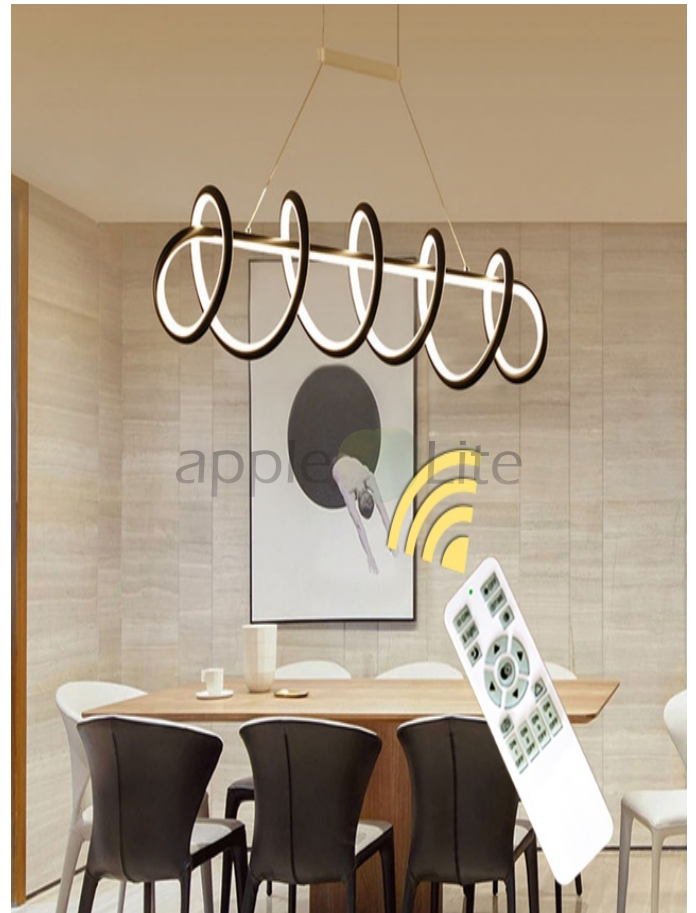

Product Code - KI-D244

Driver : In Base
 Options : Out Light \ In Light
 Body Color : White \ Black \ Brown \ Gold \ Rose Gold
 Mounting : Hanging Length 1000mm.
 Can be customized to any size
 Housing Material : Aluminum Extruded & PC Cover.

Product Code - KI-D245

Driver : In Base
 Options : Out Light \ In Light
 Body Color : White \ Black \ Brown \ Gold \ Rose Gold
 Mounting : Hanging Length 1000mm.
 Can be customized to any size
 Housing Material : Aluminum Extruded & PC Cover.

Product Code	Profile Part	Watt	Color Temp.	Beam	CRI	Dimensions	MRP.
KI-D244	KISP01	60W	WW-NW-CW	120°	>80	Dia.450mm	11200.00
KI-D244	KISP01	80W	WW-NW-CW	120°	>80	Dia.600mm	16100.00
KI-D245	KISP01	100W	WW-NW-CW	120°	>80	300x600mm	16200.00
KI-D245	KISP01	140W	WW-NW-CW	120°	>80	300x900mm	22400.00

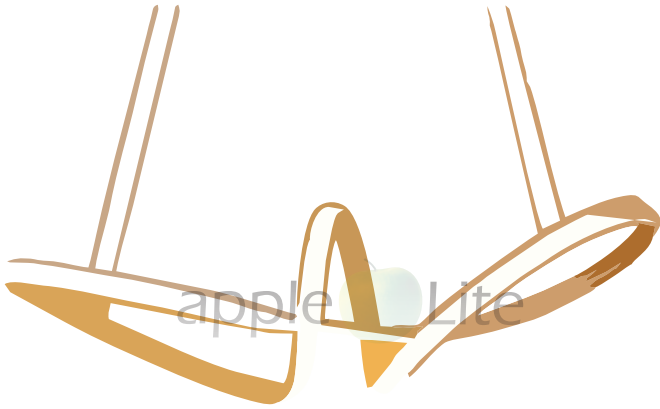

Product Code - KI-D324

Driver External : In Base
 Options : Out + In Light
 Body Color : White \ Black\ Brown \ Gold \ Rose Gold
 Mounting : Hanging Length 1000mm
 Can be customized to any size
 Housing Material : Aluminum Extruded & PC Cover.

Product Code - KI-D325

Driver External : In Base
 Options :Out + In Light
 Body Color : White \ Black\ Brown \ Gold \ Rose Gold
 Mounting : Hanging Length 1000mm
 Can be customized to any size
 Housing Material : Aluminum Extruded & PC Cover.

Product Code	Profile Part	Watt	Color Temp.	Beam	CRI	Dimensions	MRP.
KI-D324	KISP01	50W	WW-NW-CW	120°	>80	600x300mm	14500.00
KI-D325	KISP01	80W	WW-NW-CW	120°	>80	750x400mm	20100.00

Ceiling - Chandelier



Product Code - **KI-D243**

Driver: In Base

Options : Out Light \ In Light

Body Color : White \ Black \ Brown \ Gold \ Rose Gold

Mounting : Surface

Can be customized to any size

Housing Material : Aluminum Extruded & PC Cover.

Product Code - **KI-D247**

Driver : In Base

Options : Out Light \ In Light

Body Color : White \ Black \ Brown \ Gold \ Rose Gold

Mounting : Surface

Can be customized to any size

Housing Material : Aluminum Extruded & PC Cover.

Product Code	Profile Part	Watt	Color Temp.	Beam	CRI	Dimensions	MRP.
KI-D243	KISP01	50W	WW-NW-CW	120°	>80	Dia.450mm	11200.00
KI-D243	KISP01	70W	WW-NW-CW	120°	>80	Dia.600mm	16100.00
KI-D247	KISP01	60W	WW-NW-CW	120°	>80	Dia.450mm	11200.00
KI-D247	KISP01	80W	WW-NW-CW	120°	>80	Dia.600mm	16100.00

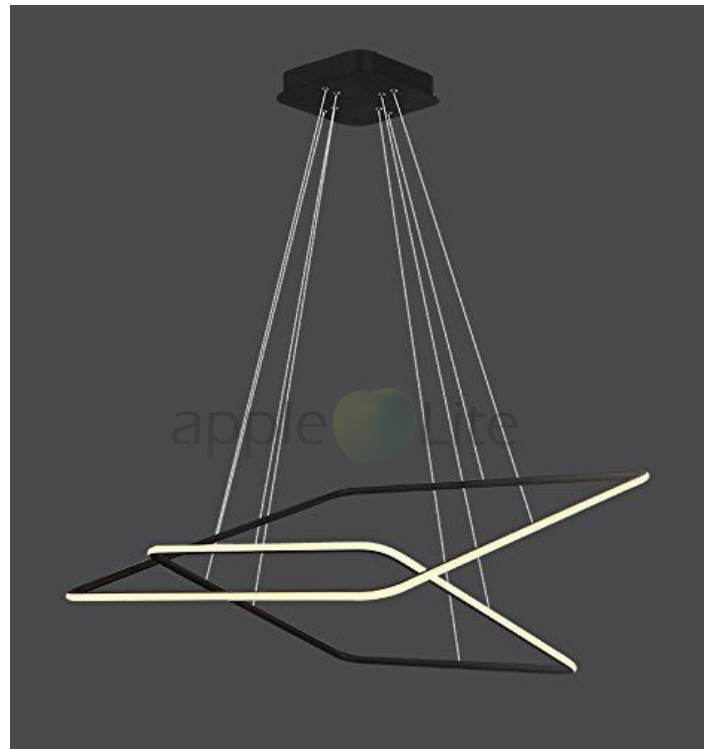

Product Code - **KI-D100**

Options : Out Light \ In Light \ Partial Light
 Body Color : White \ Black \ Brown \ Gold \ Rose Gold
 Mounting : Hanging Length 1000mm.
 Can be customized to any size
 Housing Material : Aluminum Extruded & PC Cover.

Product Code	Profile Part	Watt	Color Temp.	Beam	CRI	Dimensions	MRP.
KI-D100	KISP01	16W	WW-NW-CW	120°	>80	300mm	3800.00
KI-D100	KISP01	24W	WW-NW-CW	120°	>80	450mm	5700.00
KI-D100	KISP01	32W	WW-NW-CW	120°	>80	600mm	7600.00
KI-D100	KISP01	40W	WW-NW-CW	120°	>80	750mm	9500.00
KI-D100	KISP01	48W	WW-NW-CW	120°	>80	900mm	11400.00
KI-D100	KISP01	64W	WW-NW-CW	120°	>80	1200mm	15200.00
KI-D100	KISP01	80W	WW-NW-CW	120°	>80	1500mm	19000.00

To calculate rate for a set of 3rings of 300+450+600mm, kindly add rate of each ring respectively i.e. Rs.3800(for 300mm)+Rs.5700(for 450mm)+Rs.7600.00(for 600mm) so total for a set of 3 rings = 17100.00.



Product Code - **KI-D200**

Options : Out Light \ In Light \ Partial Light

Body Color : White \ Black \ Brown \ Gold \ Rose Gold

Mounting : Hanging Length 1000mm.

Can be customized to any size

Housing Material : Aluminum Extruded & PC Cover.

Product Code	Profile Part	Watt	Color Temp.	Beam	CRI	Dimensions	MRP.
KI-D200	KISP01	16W	WW-NW-CW	120°	>80	300mm	3800.00
KI-D200	KISP01	24W	WW-NW-CW	120°	>80	450mm	5700.00
KI-D200	KISP01	32W	WW-NW-CW	120°	>80	600mm	7600.00
KI-D200	KISP01	40W	WW-NW-CW	120°	>80	750mm	9500.00
KI-D200	KISP01	48W	WW-NW-CW	120°	>80	900mm	11400.00
KI-D200	KISP01	64W	WW-NW-CW	120°	>80	1200mm	15200.00
KI-D200	KISP01	80W	WW-NW-CW	120°	>80	1500mm	19000.00

To calculate rate for a set of 3rings of 300+450+600mm, kindly add rate of each ring respectively i.e. Rs.3800(for 300mm)+Rs.5700(for 450mm)+Rs.7600.00(for 600mm) so total for a set of 3 rings = 17100.00.

2 Side Lit Rings - Hanging



Product Code - **KI-D152**

Options : Out Light \ In Light \ Partial Light

Body Color : White \ Black \ Brown \ Gold \ Rose Gold

Mounting : Hanging Length 1000mm.

Can be customized to any size

Housing Material : Aluminum Extruded & PC Cover.

Product Code	Profile Part	Watt	Color Temp.	Beam	CRI	Dimensions	MRP.
KI-D152	KISP01	32W	WW-NW-CW	120°	>80	300mm	7600.00
KI-D152	KISP01	48W	WW-NW-CW	120°	>80	450mm	11400.00
KI-D152	KISP01	64W	WW-NW-CW	120°	>80	600mm	15200.00
KI-D152	KISP01	80W	WW-NW-CW	120°	>80	750mm	19000.00
KI-D152	KISP01	96W	WW-NW-CW	120°	>80	900mm	22800.00
KI-D152	KISP01	128W	WW-NW-CW	120°	>80	1200mm	30400.00
KI-D152	KISP01	160W	WW-NW-CW	120°	>80	1500mm	38000.00

To calculate rate for a set of 3rings of 300+450+600mm, kindly add rate of each ring respectively i.e. Rs.7600(for 300mm)+ Rs.11400(for 450mm)+Rs.15200.00(for 600mm) so total for a set of 3 rings = 34200.00.

Hexa Hanging



Product Code - KI-D704H

Driver External : In Base
 Options : Out Light \ In Light \ Partial Light
 Body Color : White \ Black \ Brown \ Gold \ Rose Gold
 Mounting : Hanging Length 1000mm.
 Can be customized to any size
 Housing Material : Aluminum Extruded & PC Cover.

Product Code - KI-D704V

Driver External : In Base
 Options : Out Light \ In Light \ Partial Light
 Body Color : White \ Black \ Brown \ Gold \ Rose Gold
 Mounting : Hanging Length 1000mm.
 Can be customized to any size
 Housing Material : Aluminum Extruded & PC Cover.

Product Code	Profile Part	Watt	Color Temp.	Beam	CRI	Dimensions	MRP.
KI-D704H	KISP01	16W	WW-NW-CW	120°	>80	Dia.300mm	3800.00
KI-D704H	KISP01	24W	WW-NW-CW	120°	>80	Dia.450mm	5700.00
KI-D704H	KISP01	32W	WW-NW-CW	120°	>80	Dia.600mm	7600.00
KI-D704V	KISP01	16W	WW-NW-CW	120°	>80	300x450mm	4800.00
KI-D704V	KISP01	24W	WW-NW-CW	120°	>80	450x600mm	6700.00
KI-D704V	KISP01	32W	WW-NW-CW	120°	>80	600x750mm	8600.00



Product Code - **KI-D200-Oval**

Options : Out Light \ In Light \ Partial Light

Body Color : White \ Black \ Brown \ Gold \ Rose Gold

Mounting : Hanging Length 1000mm.

Can be customized to any size

Housing Material : Aluminium Extruded & PC Cover.

Product Code	Profile Part	Watt	Color Temp.	Beam	CRI	Dimensions	MRP.
KI-D200-Oval	KISP01	32W	WW-NW-CW	120°	>80	300x600mm	5800.00
KI-D200-Oval	KISP01	48W	WW-NW-CW	120°	>80	600x900mm	10080.00
KI-D200-Oval	KISP05	64W	WW-NW-CW	120°	>80	600x1200mm	12500.00



Product Code - **KI-D221**

Options : Out Light \ In Light \ Partial Light
 Body Color : White \ Black \ Brown \ Gold \ Rose Gold
 Mounting : Hanging Length 1000mm.
 Can be customized to any size
 Housing Material : Aluminium Extruded & PC Cover.



Product Code - **KI-D222-V**

Options : Out Light \ In Light \ Partial Light
 Body Color : White \ Black \ Brown \ Gold \ Rose Gold
 Mounting : Hanging Length 1000mm.
 Can be customized to any size
 Housing Material : Aluminium Extruded & PC Cover.



Product Code - **KI-D223-H**

Options : Out Light \ In Light \ Partial Light
 Body Color : White \ Black \ Brown \ Gold \ Rose Gold
 Mounting : Hanging Length 1000mm.
 Can be customized to any size
 Housing Material : Aluminium Extruded & PC Cover.

Product Code	Profile Part	Watt	Color Temp.	Beam	CRI	Dimensions	MRP.
KI-D221	KISP01	40W	WW-NW-CW	120°	>80	450mm	9700.00
KI-D221	KISP01	48W	WW-NW-CW	120°	>80	600mm	11900.00
KI-D222-V	KISP01	64W	WW-NW-CW	120°	>80	750mm	11200.00
KI-D223-H	KISP01	64W	WW-NW-CW	120°	>80	1200mm	11200.00



Product Code - **KI-D122-2**

Driver External

Options : Out Light \ In Light \ Partial Light

Body Color : White \ Black \ Brown \ Gold \ Rose Gold

Mounting : Hanging Length 1000mm.

Can be customized to any size

Housing Material : Aluminum Extruded & PC Cover.



Product Code - **KI-D122-3**

Driver External

Options : Out Light \ In Light \ Partial Light

Body Color : White \ Black \ Brown \ Gold \ Rose Gold

Mounting : Hanging Length 1000mm.

Can be customized to any size

Housing Material : Aluminum Extruded & PC Cover.

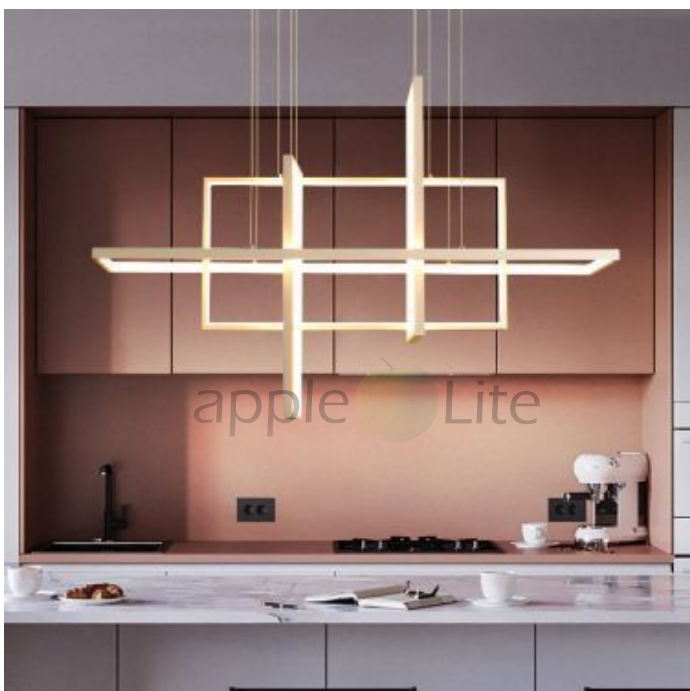

Product Code - **KI-D122-4**

Driver External

Options : Out Light \ In Light \ Partial Light

Body Color : White \ Black \ Brown \ Gold \ Rose Gold

Mounting : Hanging Length 1000mm.

Can be customized to any size

Housing Material : Aluminum Extruded & PC Cover.

Product Code	Profile Part	Watt	Color Temp.	Beam	CRI	Dimensions(LxWxH)	MRP.
KI-D122-2	KISP01	16W	WW-NW-CW	120°	>80	750x300x300mm	11600.00
KI-D122-3	KISP01	24W	WW-NW-CW	120°	>80	750x300x450mm	16300.00
KI-D122-4	KISP01	32W	WW-NW-CW	120°	>80	600x300x750mm	20830.00



Product Code	Profile Part	Watt	Color Temp.	Beam	CRI	Dimensions	MRP.
KI-D122-H	KISP02	176w	WW-NW-CW	120°	>80	450x450x1200mm	40320.00



Product Code - **KI-D121**
 Driver External
 Options : Out Light \ In Light \ Partial Light
 Body Color : White \ Black \ Brown \ Gold \ Rose Gold
 Can be customized to any size
 Housing Material : Aluminum Extruded & PC Cover.



Product Code - **KI-D121-O**
 Driver External
 Options : Out Light \ In Light \ Partial Light
 Body Color : White \ Black \ Brown \ Gold \ Rose Gold.
 Can be customized to any size
 Housing Material : Aluminum Extruded & PC Cover.

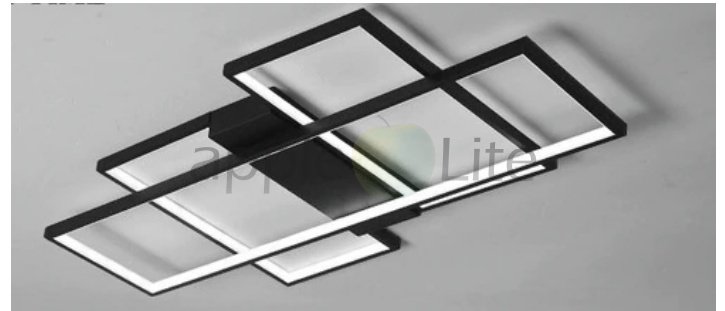

Product Code - **KI-D121-C**
 Driver External
 Options : Out Light \ In Light \ Partial Light
 Body Color : White \ Black \ Brown \ Gold \ Rose Gold.
 Can be customized to any size
 Housing Material : Aluminum Extruded & PC Cover.

Product Code	Profile Part	Watt	Color Temp.	Beam	CRI	Dimensions(LxBxH)	MRP.
KI-D121	KISP02	50W	WW-NW-CW	120°	>80	350x530x80mm	5850.00
KI-D121	KISP02	100W	WW-NW-CW	120°	>80	760x1100x80mm	11200.00
KI-D121-O	KISP01	50W	WW-NW-CW	120°	>80	350x530x80mm	5850.00
KI-D121-O	KISP01	100W	WW-NW-CW	120°	>80	760x1100x80mm	11200.00
KI-D121-C	KISP02	50W	WW-NW-CW	120°	>80	600x450x80mm	6850.00



Product Code - **KI-D700H-SS**

Driver External

Options : Out Light \ In Light \ Partial Light

Body Color : Gold \ Rose Gold \ Nickel

Mounting : Hanging Length 1000mm.

Can be customized to any size

Housing Material : Aluminum Extruded & PC Cover.

Product Code	Profile Part	Watt	Color Temp.	Beam	CRI	Dimensions	MRP.
KI-D700H-SS	25/35/50mm	24W	WW-NW-CW	120°	>80	Dia. 300mm	22400.00
KI-D700H-SS	25/35/50mm	36W	WW-NW-CW	120°	>80	Dia. 450mm	31360.00
KI-D700H-SS	25/35/50mm	50W	WW-NW-CW	120°	>80	Dia. 600mm	40320.00
KI-D700H-SS	25/35/50mm	60W	WW-NW-CW	120°	>80	Dia. 750mm	58240.00



Product Code - **KI-D700H**

Driver External

Options : Out Light \ In Light \ Partial Light

Body Color : White \ Black \ Brown \ Gold \ Rose Gold

Mounting : Hanging Length 1000mm.

Can be customized to any size

Housing Material : Aluminum Extruded & PC Cover.

Product Code	Profile Part	Watt	Color Temp.	Beam	CRI	Dimensions	MRP.
KI-D700H	50mm	24W	WW-NW-CW	120°	>80	Dia. 300mm	6720.00
KI-D700H	50mm	36W	WW-NW-CW	120°	>80	Dia. 450mm	8960.00
KI-D700H	50mm	50W	WW-NW-CW	120°	>80	Dia. 600mm	11200.00
KI-D700H	50mm	60W	WW-NW-CW	120°	>80	Dia. 750mm	15680.00
KI-D700H	50mm	80W	WW-NW-CW	120°	>80	Dia. 900mm	17980.00
KI-D700H	50mm	100W	WW-NW-CW	120°	>80	Dia. 1200mm	29120.00



Product Code - **KI-D700H-Cut**

Driver External

Options : Out Light \ In Light \ Partial Light

Body Color : White \ Black \ Brown \ Gold \ Rose Gold

Mounting : Hanging Length 1000mm.

Can be customized to any size

Housing Material : Aluminum Extruded & PC Cover.

Product Code - **KI-D700H-Cut-SS**

Driver External

Options : Out Light \ In Light \ Partial Light

Body Color : White \ Black \ Brown \ Gold \ Rose Gold

Mounting : Hanging Length 1000mm.

Can be customized to any size

Housing Material : Aluminum Extruded & PC Cover.

Product Code	Profile Part	Watt	Color Temp.	Beam	CRI	Dimensions	MRP.
KI-D700H-Cut	25/35/50mm	24W	WW-NW-CW	120°	>80	Dia. 300mm	7720.00
KI-D700H-Cut	25/35/50mm	36W	WW-NW-CW	120°	>80	Dia. 450mm	9960.00
KI-D700H-Cut	25/35/50mm	50W	WW-NW-CW	120°	>80	Dia. 600mm	12200.00
KI-D700H-Cut-SS	25/35/50mm	60W	WW-NW-CW	120°	>80	Dia. 300mm	23400.00
KI-D700H-Cut-SS	25/35/50mm	60W	WW-NW-CW	120°	>80	Dia. 450mm	32360.00
KI-D700H-Cut-SS	25/35/50mm	60W	WW-NW-CW	120°	>80	Dia. 600mm	41320.00



Product Code - **KI-D700H-SPOT**

Driver External

Options : Down - Partial Light

Body Color : White \ Black\ Brown \ Gold \ Rose Gold

Mounting : Hanging Length 1000mm.

Can be customized to any size

Housing Material : Aluminum Extruded & PC Cover.

Product Code - **KI-D700-Cut-SPOT**

Driver External

Options : Down - Partial Light

Body Color : White \ Black\ Brown \ Gold \ Rose Gold

Mounting : Hanging Length 1000mm.

Can be customized to any size

Housing Material : Aluminum Extruded & PC Cover.

Product Code	Profile Part	Watt	Color Temp.	Beam	CRI	Dimensions	MRP.
KI-D700H-SPOT4	50mm	24W	WW-NW-CW	120°	>80	Dia. 300mm	8960.00
KI-D700H-SPOT6	50mm	36W	WW-NW-CW	120°	>80	Dia. 450mm	13440.00
KI-D700H-SPOT8	50mm	50W	WW-NW-CW	120°	>80	Dia. 600mm	17920.00
KI-D700H-CutSpot4	50mm	60W	WW-NW-CW	120°	>80	Dia. 750mm	9960.00
KI-D700H-CutSpot6	50mm	60W	WW-NW-CW	120°	>80	Dia. 900mm	14440.00
KI-D700H-CutSpot8	50mm	60W	WW-NW-CW	120°	>80	Dia. 1200mm	18920.00

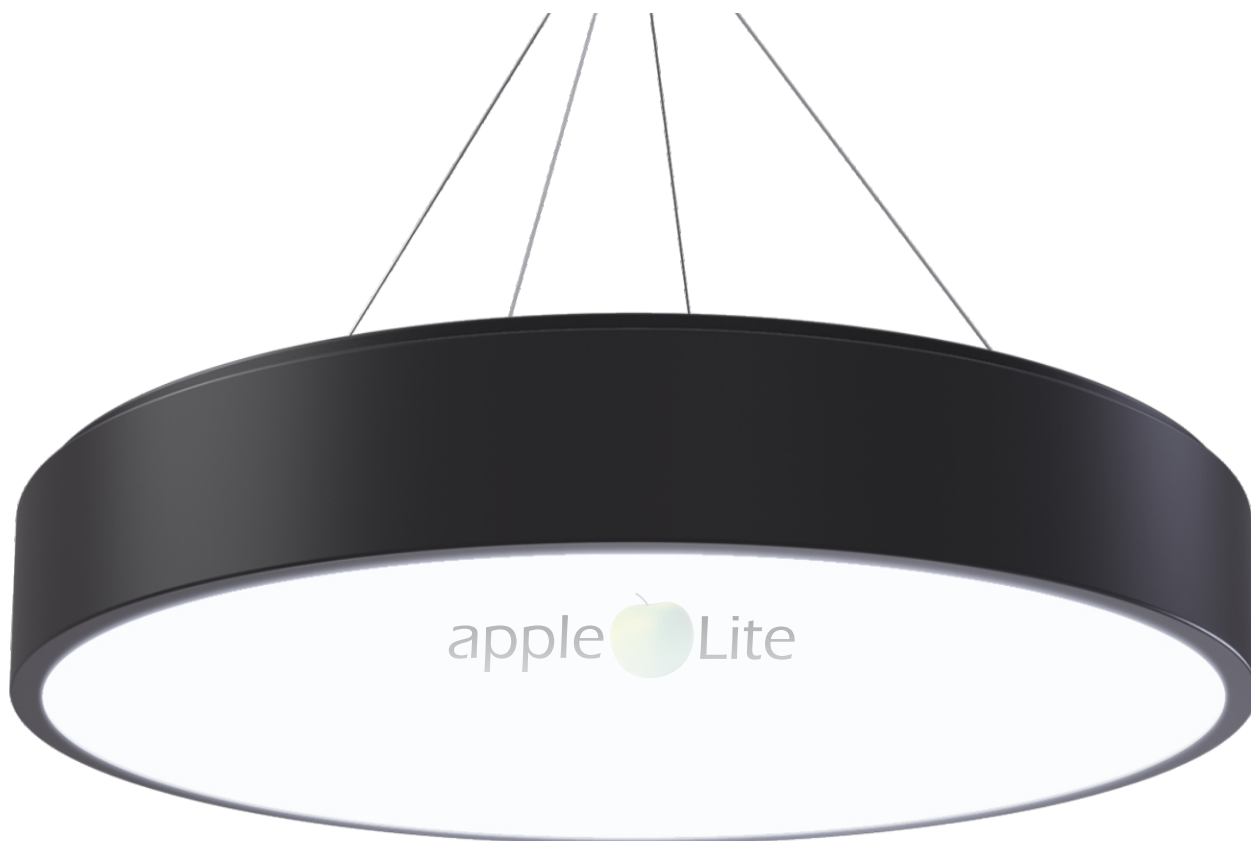

Product Code - **KI-D700-F**

Driver External

Options : Down Light

Body Color : White \ Black \ Brown \ Gold \ Rose Gold

Mounting : Hanging Length 1000mm.

Can be customized to any size

Housing Material : Aluminum Extruded & PC Cover.

Product Code	Profile Part	Watt	Color Temp.	Beam	CRI	Dimensions	MRP.
KI-D700F	NA	24W	WW-NW-CW	120°	>80	Dia. 300mm	7720.00
KI-D700F	NA	36W	WW-NW-CW	120°	>80	Dia. 450mm	9960.00
KI-D700F	NA	50W	WW-NW-CW	120°	>80	Dia. 600mm	12200.00
KI-D700F	NA	60W	WW-NW-CW	120°	>80	Dia. 750mm	16680.00
KI-D700F	NA	80W	WW-NW-CW	120°	>80	Dia. 900mm	18980.00
KI-D700F	NA	100W	WW-NW-CW	120°	>80	Dia. 1200mm	30120.00



Product Code - **KI-D703-F**

Driver External

Options : Out Light \ In Light \ Partial Light

Body Color : White \ Black \ Brown \ Gold \ Rose Gold

Mounting : Hanging Length 1000mm.

Can be customized to any size

Housing Material : Aluminum Extruded & PC Cover.

Product Code - **KI-D703-H**

Driver External

Options : Out Light \ In Light \ Partial Light

Body Color : White \ Black \ Brown \ Gold \ Rose Gold

Mounting : Hanging Length 1000mm.

Can be customized to any size

Housing Material : Aluminum Extruded & PC Cover.

Product Code	Profile Part	Watt	Color Temp.	Beam	CRI	Dimensions	MRP.
KI-D703F	50mm	24W	WW-NW-CW	120°	>80	Dia. 300mm	7720.00
KI-D703F	50mm	36W	WW-NW-CW	120°	>80	Dia. 450mm	9960.00
KI-D703F	50mm	50W	WW-NW-CW	120°	>80	Dia. 600mm	12200.00
KI-D703H	50mm	24W	WW-NW-CW	120°	>80	Dia. 300mm	8450.00
KI-D703H	50mm	36W	WW-NW-CW	120°	>80	Dia. 450mm	11850.00
KI-D703H	50mm	50W	WW-NW-CW	120°	>80	Dia. 600mm	14500.00



Product Code - **KI-D701F**

Driver External

Options : Out Light \ In Light \ Partial Light

Body Color : White \ Black \ Brown \ Gold \ Rose Gold

Mounting : Hanging Length 1000mm.

Can be customized to any size

Housing Material : Aluminum Extruded & PC Cover.

Product Code - **KI-D701H**

Driver External

Options : Out Light \ In Light \ Partial Light

Body Color : White \ Black \ Brown \ Gold \ Rose Gold

Mounting : Hanging Length 1000mm.

Can be customized to any size

Housing Material : Aluminum Extruded & PC Cover.

Product Code	Profile Part	Watt	Color Temp.	Beam	CRI	Dimensions	MRP.
KI-D701F	NA	24W	WW-NW-CW	120°	>80	300mm	6720.00
KI-D701F	NA	36W	WW-NW-CW	120°	>80	450mm	8960.00
KI-D701F	NA	50w	WW-NW-CW	120°	>80	600mm	11200.00
KI-D701H	NA	32W	WW-NW-CW	120°	>80	300mm	7720.00
KI-D701H	NA	40W	WW-NW-CW	120°	>80	450mm	9960.00
KI-D701H	NA	50W	WW-NW-CW	120°	>80	600mm	12200.00



Product Code - **KI-D702F**

Driver External

Options : Out Light \ In Light \ Partial Light

Body Color : White \ Black \ Brown \ Gold \ Rose Gold

Mounting : Hanging Length 1000mm.

Can be customized to any size

Housing Material : Aluminum Extruded & PC Cover.

Product Code - **KI-D702H**

Driver External

Options : Out Light \ In Light \ Partial Light

Body Color : White \ Black \ Brown \ Gold \ Rose Gold

Mounting : Hanging Length 1000mm.

Can be customized to any size

Housing Material : Aluminum Extruded & PC Cover.

Product Code	Profile Part	Watt	Color Temp.	Beam	CRI	Dimensions	MRP.
KI-D702F	NA	24W	WW-NW-CW	120°	>80	300mm	6720.00
KI-D702F	NA	36W	WW-NW-CW	120°	>80	450mm	8960.00
KI-D702F	NA	50w	WW-NW-CW	120°	>80	600mm	11200.00
KI-D702H	NA	32W	WW-NW-CW	120°	>80	300mm	7720.00
KI-D702H	NA	40W	WW-NW-CW	120°	>80	450mm	9960.00
KI-D702H	NA	50W	WW-NW-CW	120°	>80	600mm	12200.00



Product Code - **KI-DAbot1**

Driver External

Options : Out Light \ In Light \ Partial Light

Body Color : White \ Black \ Brown \ Gold \ Rose Gold

Mounting : Hanging Length 1000mm.

Can be customized to any size

Housing Material : Aluminum Extruded & PC Cover.

Product Code - **KI-DAbot2**

Driver External

Options : Out Light \ In Light \ Partial Light

Body Color : White \ Black \ Brown \ Gold \ Rose Gold

Mounting : Hanging Length 1000mm.

Can be customized to any size

Housing Material : Aluminum Extruded & PC Cover.

Product Code	Profile Part	Watt	Color Temp.	Beam	CRI	Dimensions	MRP.
KI-DAbot-1	KISP01	32W	WW-NW-CW	120°	>80	300x600mm	8200.00
KI-DAbot-2	KISP01	24W	WW-NW-CW	120°	>80	300x500mm	7200.00



Product Code - **KI-DAbot-3**

Driver External

Options : Out Light \ In Light \ Partial Light

Body Color : White \ Black \ Brown \ Gold \ Rose Gold

Mounting : Hanging Length 1000mm.

Can be customized to any size

Housing Material : Aluminum Extruded & PC Cover.

Product Code - **KI-DAbot-4**

Driver External

Options : Out Light \ In Light \ Partial Light

Body Color : White \ Black \ Brown \ Gold \ Rose Gold

Mounting : Hanging Length 1000mm.

Can be customized to any size

Housing Material : Aluminum Extruded & PC Cover.

Product Code	Profile Part	Watt	Color Temp.	Beam	CRI	Dimensions	MRP.
KI-DAbot-3	KISP01	80W	WW-NW-CW	120°	>80	1500x450mm	20160.00
KI-DAbot-4	KISP01	64W	WW-NW-CW	120°	>80	900x10000mm	18000.00



Product Code - **KI-D-Guitar**
 Body Color : White \ Black\ Brown \ Gold \ Rose Gold
 Can be customized to any size
 Housing Material : Aluminum Extruded & PC Cover.



Product Code - **KI-D-Cycle**
 Body Color : White \ Black\ Brown \ Gold \ Rose Gold
 Can be customized to any size
 Housing Material : Aluminum Extruded & PC Cover.



Product Code - **KI-D-Ganesh**
 Body Color : White \ Black\ Brown \ Gold \ Rose Gold
 Can be customized to any size
 Housing Material : Aluminum Extruded & PC Cover.



Product Code - **KI-D-Om**
 Body Color : White \ Black\ Brown \ Gold \ Rose Gold
 Can be customized to any size
 Housing Material : Aluminum Extruded & PC Cover.

Product Code	Profile Part	Watt	Color Temp.	Beam	CRI	Dimensions	MRP.
KI-D-Guitar	KISP01	36W	WW-NW-CW	120°	>80	900x300mm	11200.00
KI-D-Cycle	KISP01	24W	WW-NW-CW	120°	>80	600x400mm	11200.00
KI-D-Ganesh	KISP01	36W	WW-NW-CW	120°	>80	450x500mm	11200.00
KI-D-Om	KISP01	50W	WW-NW-CW	120°	>80	300x300mm	7900.00



Product Code - **KI-D-Letter**
 Driver External
 Options : Out Light \ In Light \ Partial Light
 Body Color : White \ Black \ Brown \ Gold \ Rose Gold
 Mounting : Hanging Length 1000mm.
 Can be customized to any size
 Housing Material : Aluminum Extruded & PC Cover.



Product Code - **KI-D-Letter**
 Driver External
 Options : Out Light \ In Light \ Partial Light
 Body Color : White \ Black \ Brown \ Gold \ Rose Gold
 Mounting : Hanging Length 1000mm.
 Can be customized to any size
 Housing Material : Aluminum Extruded & PC Cover.

Product Code	Profile Part	Watt	Color Temp.	Beam	CRI	Dimensions	MRP.
KI-D-Letter	KISP01	84W	WW-NW-CW	120°	>80	300x1200mm	15700.00

Square & Round Wall light



Product Code - **KI-D150**

Driver External - In Base

Options : Out Light \ In Lightt

Body Color : White \ Black\ Brown \ Gold \ Rose Gold

Mounting : Wall Light.

Can be customized to any size

Housing Material : Aluminum Extruded & PC Cover.

Product Code - **KI-D250**

Driver External - In Base

Options : Out Light \ In Light

Body Color : White \ Black\ Brown \ Gold \ Rose Gold

Mounting : Wall Light.

Can be customized to any size

Housing Material : Aluminum Extruded & PC Cover.

Product Code	Profile Part	Watt	Color Temp.	Beam	CRI	Dimensions	MRP.
KI-D150	KISP01	20W	WW-NW-CW	120°	>80	300x300mm	4480.00
KI-D250	KISP01	20W	WW-NW-CW	120°	>80	Dia.300mm	4480.00



Product Code - **KI-D310-S**
 Driver External : In Base
 Options : Down + In Light
 Body Color : White \ Black \ Brown \ Gold \ Rose Gold
 Mounting : Surface Ceiling
 Can be customized to any size
 Housing Material : Aluminum Extruded & PC Cover.



Product Code - **KI-D310-R**
 Driver External : In Base
 Options : In Light
 Body Color : White \ Black \ Brown \ Gold \ Rose Gold
 Mounting : Surface Ceiling
 Can be customized to any size
 Housing Material : Aluminum Extruded & PC Cover.

Product Code	Profile Part	Watt	Color Temp.	Beam	CRI	Dimensions	MRP.
KI-D310-S	KISP01	50W	WW-NW-CW	120°	>80	300x300mm	5600.00
KI-D310-R	KISP01	36W	WW-NW-CW	120°	>80	Dia. 300mm	5600.00



Product Code - **KI-D159-IL**

Driver External

Options : In Light

Body Color : White \ Black\ Brown \ Gold \ Rose Gold

Mounting : Hanging Length 1000mm.

Can be customized to any size

Housing Material : Aluminum Extruded & PC Cover.

Product Code	Profile Part	Watt	Color Temp.	Beam	CRI	Dimensions	MRP.
KI-D159-IL	KICP01	80W	WW-NW-CW	120°	>80	300x300x900mm	24640.00

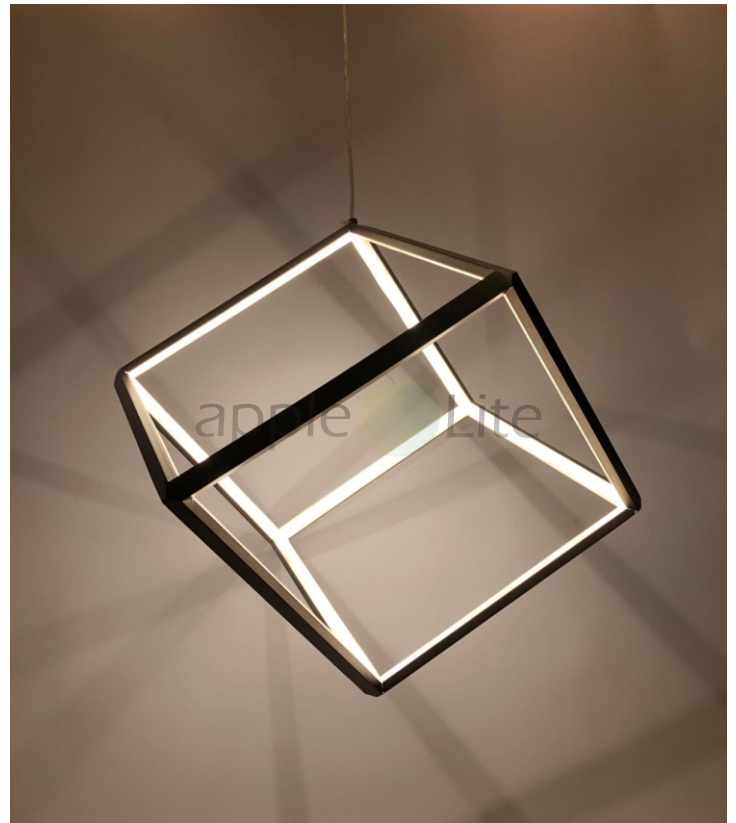

Product Code - **KI-D155**

Driver External

Options : In Light

Body Color : White \ Black \ Brown \ Gold \ Rose Gold

Mounting : Hanging Length 1000mm.

Can be customized to any size

Housing Material : Aluminum Extruded & PC Cover.

Product Code	Profile Part	Watt	Color Temp.	Beam	CRI	Dimensions	MRP.
KI-D155	KICP01	60W	WW-NW-CW	120°	>80	300x300mm	10800.00
KI-D155	KICP01	90W	WW-NW-CW	120°	>80	450x450mm	17300.00
KI-D155	KICP01	120W	WW-NW-CW	120°	>80	600x600mm	23800.00
KI-D155	KICP01	180W	WW-NW-CW	120°	>80	900x900mm	34500.00



Product Code - **KI-D157-IL**

Driver External

Options : In Light

Body Color : White \ Black\ Brown \ Gold \ Rose Gold

Mounting : Hanging Length 1000mm.

Can be customized to any size

Housing Material : Aluminum Extruded & PC Cover.

Product Code - **KI-D158-IL**

Driver External

Options : In Light

Body Color : White \ Black\ Brown \ Gold \ Rose Gold

Mounting : Hanging Length 1000mm.

Can be customized to any size

Housing Material : Aluminum Extruded & PC Cover.

Product Code	Profile Part	Watt	Color Temp.	Beam	CRI	Dimensions	MRP.
KI-D157-IL	KICP01	160W	WW-NW-CW	120°	>80	300x300x1800mm	49800.00
KI-D158-IL	KICP01	200W	WW-NW-CW	120°	>80	300x300x2400mm	58200.00



Product Code - **KI-D227**

Driver : In Base
 Options : Out Light \ In Light
 Body Color : White \ Black \ Brown \ Gold \ Rose Gold
 Mounting : Surface
 Can be customized to any size
 Housing Material : Aluminum Extruded & PC Cover.

Product Code - **KI-D242**

Driver : In base
 Options : Out Light \ In Light
 Body Color : White \ Black \ Brown \ Gold \ Rose Gold
 Mounting : Surface
 Can be customized to any size
 Housing Material : Aluminum Extruded & PC Cover.

Product Code	Profile Part	Watt	Color Temp.	Beam	CRI	Dimensions	MRP.
KI-D227	KISP01	96W	WW-NW-CW	120°	>80	Dia. 600mm	26400.00
KI-D242	KISP01	144W	WW-NW-CW	120°	>80	Dia. 900mm	34500.00

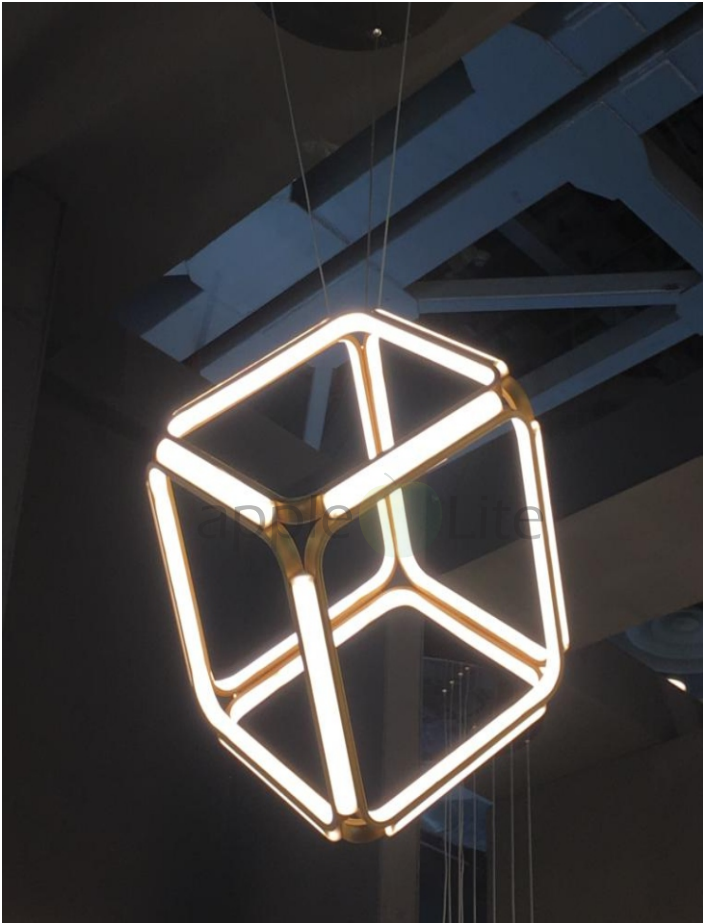

Product Code - **KI-D231-D**

Driver External
 Options : Out Light & In Light
 Body Color : White \ Black \ Brown \ Gold \ Rose Gold
 Mounting : Hanging Length 1000mm.
 Can be customized to any size
 Housing Material : Aluminum Extruded & PC Cover.

Product Code - **KI-D232**

Driver External
 Options : Out Light \ In Light
 Body Color : White \ Black \ Brown \ Gold \ Rose Gold
 Mounting : Hanging Length 1000mm.
 Can be customized to any size
 Housing Material : Aluminum Extruded & PC Cover.

Product Code	Profile Part	Watt	Color Temp.	Beam	CRI	Dimensions	MRP.
KI-D231-3D	KISP01+CP01	180W	WW-NW-CW	120°	>80	300mm	25400.00
KI-D232	KISP01	108W	WW-NW-CW	120°	>80	450mm	17300.00



Product Code - KI-D238

Driver : In Base
 Options : Out Light \ In Light
 Body Color : White \ Black \ Brown \ Gold \ Rose Gold
 Mounting : Surface
 Can be customized to any size
 Housing Material : Aluminum Extruded & PC Cover.

Product Code - KI-D239

Driver : In Base
 Options : Out Light \ In Light
 Body Color : White \ Black \ Brown \ Gold \ Rose Gold
 Mounting : Surface.
 Can be customized to any size
 Housing Material : Aluminum Extruded & PC Cover.

Product Code	Profile Part	Watt	Color Temp.	Beam	CRI	Dimensions	MRP.
KI-D238	KISP01	150W	WW-NW-CW	120°	>80	600x600mm	21200.00
KI-D238	KISP01	225W	WW-NW-CW	120°	>80	900x900mm	29200.00
KI-D239	KISP01	160W	WW-NW-CW	120°	>80	600x900mm	31800.00
KI-D239	KISP01	250W	WW-NW-CW	120°	>80	900x1200mm	50850.00



Product Code - KI-D248

Driver External : In Base
 Options : Out Light \ In Light \ Partial Light
 Body Color : White \ Black \ Brown \ Gold \ Rose Gold
 Mounting : Hanging Length 1000mm.
 Can be customized to any size
 Housing Material : Aluminum Extruded & PC Cover.

Product Code - KI-D249

Driver External : In Base
 Options : Out Light \ In Light \ Partial Light
 Body Color : White \ Black \ Brown \ Gold \ Rose Gold
 Mounting : Hanging Length 1000mm.
 Can be customized to any size
 Housing Material : Aluminum Extruded & PC Cover.

Product Code	Profile Part	Watt	Color Temp.	Beam	CRI	Dimensions	MRP.
KI-D248	KISP01	16W	WW-NW-CW	120°	>80	600mm	16800.00
KI-D248	KISP01	24W	WW-NW-CW	120°	>80	900mm	24640.00
KI-D249	KISP01	80W	WW-NW-CW	120°	>80	300x1200mm	16500.00



Product Code - **KI-D250**

Driver External : In Base

Options : In Light

Body Color : White \ Black\ Brown \ Gold \ Rose Gold

Mounting : Hanging Length 1000mm.

Can be customized to any size

Housing Material : Aluminum Extruded & PC Cover.

Product Code	Profile Part	Watt	Color Temp.	Beam	CRI	Dimensions	MRP.
KI-D250-1pot	KISP01	16W	WW-NW-CW	120°	>80	300x300x300mm	7840.00
KI-D250-2pot	KISP01	32W	WW-NW-CW	120°	>80	450x300x300mm	15680.00
KI-D250-3pot	KISP01	48W	WW-NW-CW	120°	>80	600x300x300mm	23520.00

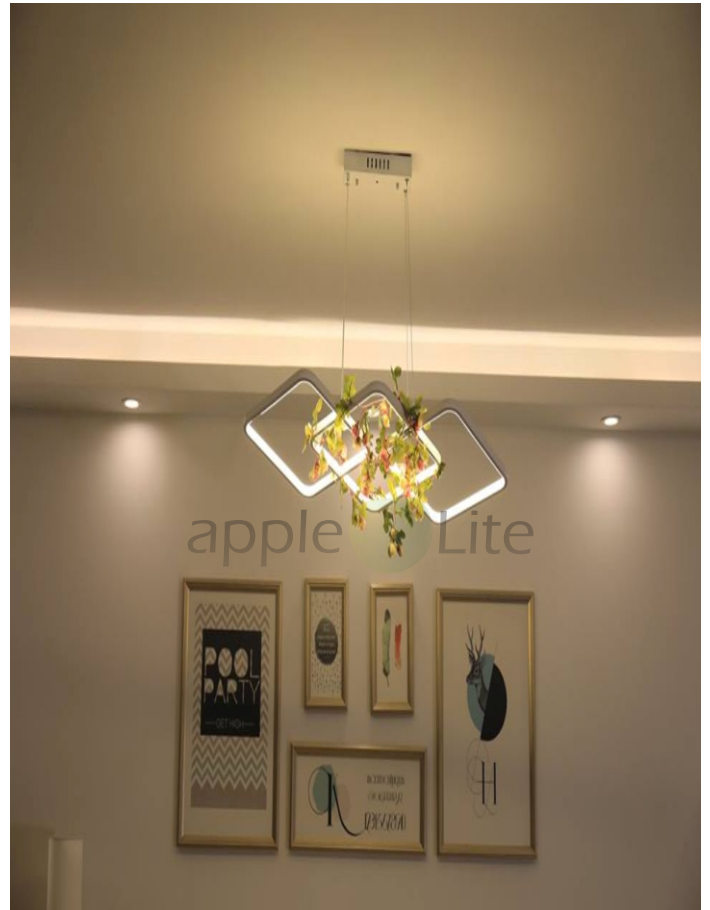

Product Code - KI-D251

Driver External : In Base
 Options : Out Light \ In Light \ Partial Light
 Body Color : White \ Black \ Brown \ Gold \ Rose Gold
 Mounting : Hanging Length 1000mm.
 Can be customized to any size
 Housing Material : Aluminum Extruded & PC Cover.

Product Code - KI-D252

Driver External : In Base
 Options : Out Light \ In Light
 Body Color : White \ Black \ Brown \ Gold \ Rose Gold
 Mounting : Hanging Length 1000mm.
 Can be customized to any size
 Housing Material : Aluminum Extruded & PC Cover.

Product Code	Profile Part	Watt	Color Temp.	Beam	CRI	Dimensions	MRP.
KI-D200-D	KISP01	16W	WW-NW-CW	120°	>80	300mm	4200.00
KI-D200-D	KISP01	24W	WW-NW-CW	120°	>80	450mm	6000.00
KI-D200-W	KISP01	32W	WW-NW-CW	120°	>80	300mm	4200.00
KI-D200-W	KISP01	40W	WW-NW-CW	120°	>80	450mm	6000.00
KI-D200-W	KISP01	48W	WW-NW-CW	120°	>80	600mm	8300.00

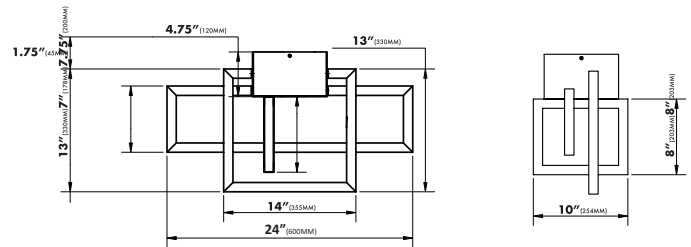

Overall Dimension : 600x254x375mm

Product Code - KI-D500

Driver External : In Base
 Options : Down + In Light
 Body Color : White \ Black \ Brown \ Gold \ Rose Gold
 Mounting : Surface Ceiling
 Can be customized to any size
 Housing Material : Aluminum Extruded & PC Cover.

Product Code - KI-D124

Driver External : In Base
 Options : In Light
 Body Color : White \ Black \ Brown \ Gold \ Rose Gold
 Mounting : Surface Ceiling
 Can be customized to any size
 Housing Material : Aluminum Extruded & PC Cover.

Product Code	Profile Part	Watt	Color Temp.	Beam	CRI	Dimensions	MRP.
KI-D500-S	KISP05	50W	WW-NW-CW	120°	>80	900x300x100mm	14600.00
KI-D500-B	KISP05	50W	WW-NW-CW	120°	>80	1200x300x100mm	15600.00
KI-D124	KISP02	90W	WW-NW-CW	120°	>80	600x275x375mm	13500.00



Product Code - **KI-D311**

Driver External : In Base
 Options : Down + In Light
 Body Color : White \ Black\ Brown \ Gold \ Rose Gold
 Mounting : Surface Ceiling
 Can be customized to any size
 Housing Material : Aluminum Extruded & PC Cover.

Product Code - **KI-D312**

Driver External : In Base
 Options : In Light
 Body Color : White \ Black\ Brown \ Gold \ Rose Gold
 Mounting : Surface Ceiling
 Can be customized to any size
 Housing Material : Aluminum Extruded & PC Cover.

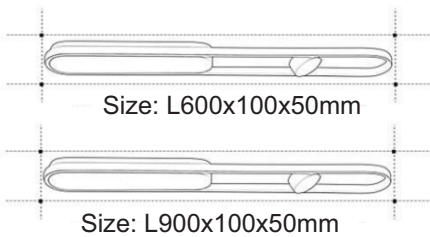

Product Code	Profile Part	Watt	Color Temp.	Beam	CRI	Dimensions	MRP.
KI-D311-B	KISP01	50W	WW-NW-CW	120°	>80	900x100x100mm	17500.00
KI-D311-S	KISP01	36W	WW-NW-CW	120°	>80	600x100x100mm	15500.00
KI-D312-B	KISP01	50W	WW-NW-CW	120°	>80	900x100x100mm	21000.00
KI-D312-S	KISP01	50W	WW-NW-CW	120°	>80	600x100x100mm	18000.00



Product Code - **KI-D300**

Driver External : In Base
 Options : Down + In Light
 Body Color : White \ Black\ Brown \ Gold \ Rose Gold
 Mounting : Surface Ceiling
 Can be customized to any size
 Housing Material : Aluminum Extruded & PC Cover.



Product Code - **KI-D301**

Driver External : In Base
 Options : In Light
 Body Color : White \ Black\ Brown \ Gold \ Rose Gold
 Mounting : Surface Ceiling
 Can be customized to any size
 Housing Material : Aluminum Extruded & PC Cover.

Product Code	Profile Part	Watt	Color Temp.	Beam	CRI	Dimensions	MRP.
KI-D300	KIS35	50W	WW-NW-CW	120°	>80	600x600mm	15400.00
KI-D301	KIS35	50W	WW-NW-CW	120°	>80	600x600mm	12600.00

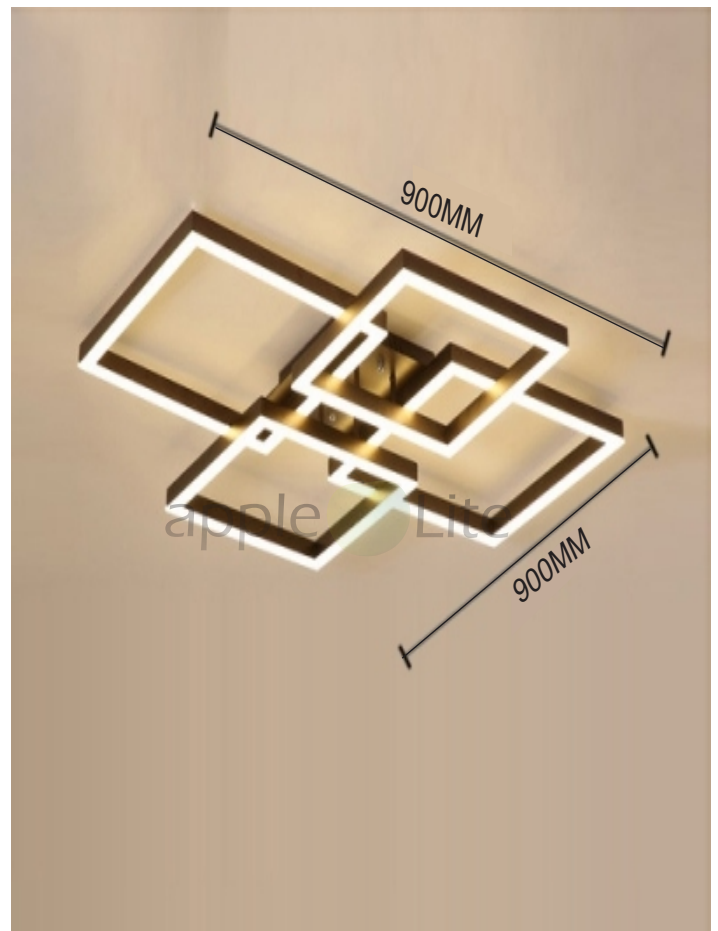
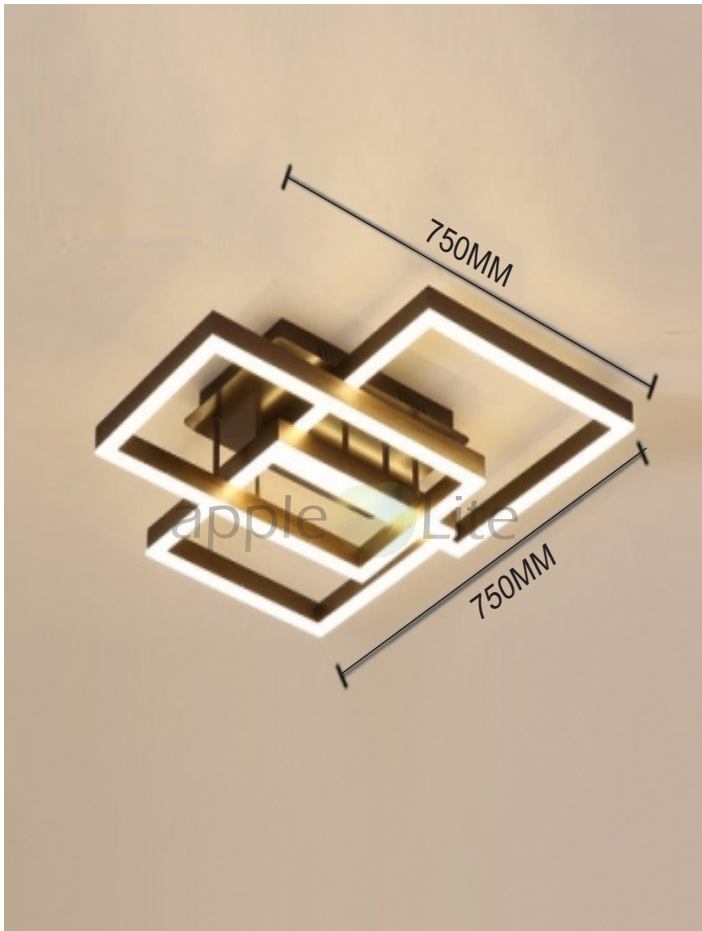

Product Code - **KI-D302**

Driver External : In Base
 Options : Down + In Light
 Body Color : White \ Black\ Brown \ Gold \ Rose Gold
 Mounting : Surface Ceiling
 Can be customized to any size
 Housing Material : Aluminum Extruded & PC Cover.

Product Code - **KI-D303**

Driver External : In Base
 Options : In Light
 Body Color : White \ Black\ Brown \ Gold \ Rose Gold
 Mounting : Surface Ceiling
 Can be customized to any size
 Housing Material : Aluminum Extruded & PC Cover.

Product Code	Profile Part	Watt	Color Temp.	Beam	CRI	Dimensions	MRP.
KI-D302	KIS35	50W	WW-NW-CW	120°	>80	750x750mm	14400.00
KI-D303	KIS35	80W	WW-NW-CW	120°	>80	900x900mm	22500.00

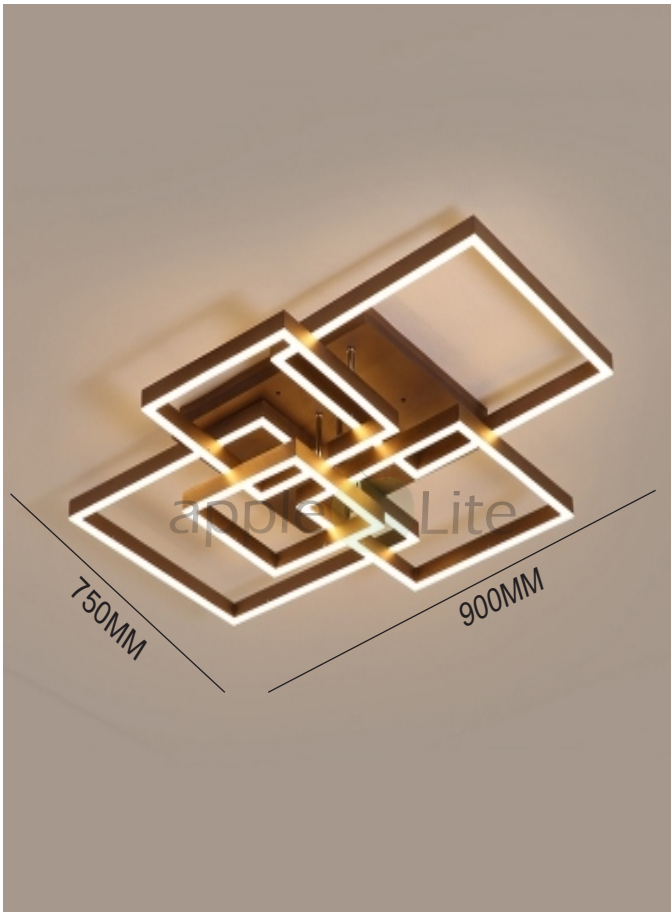

Product Code - **KI-D304**

Driver External : In Base

Options : Down + In Light

Body Color : White \ Black \ Brown \ Gold \ Rose Gold

Mounting : Surface Ceiling

Can be customized to any size

Housing Material : Aluminum Extruded & PC Cover.

Product Code	Profile Part	Watt	Color Temp.	Beam	CRI	Dimensions	MRP.
KI-D304	KIS35	50W	WW-NW-CW	120°	>80	900x750mm	22500.00

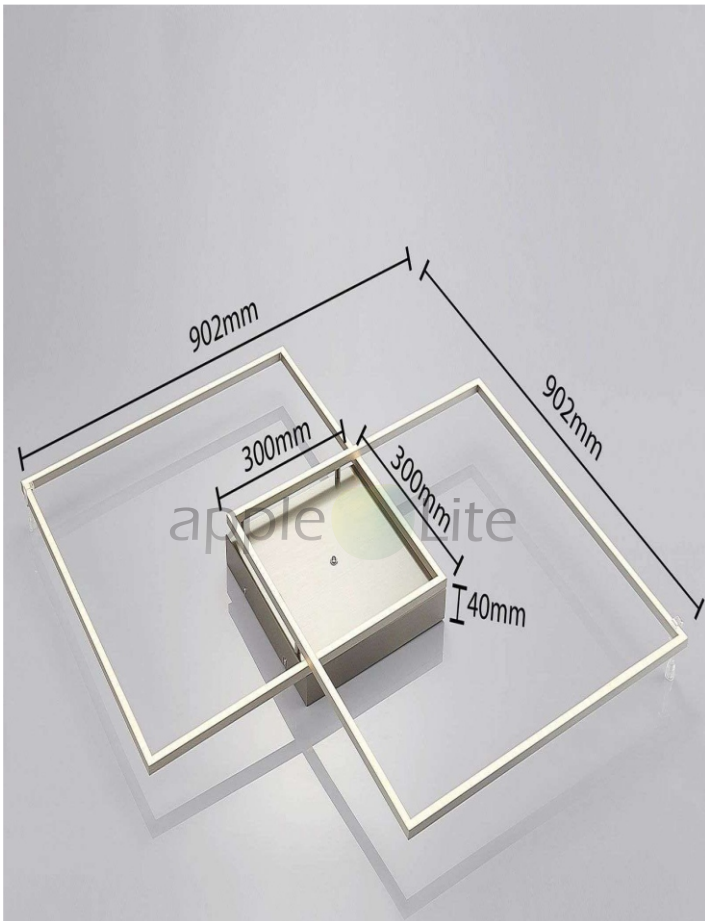

Product Code - KI-D305

Driver External : In Base
 Options : Down + In Light
 Body Color : White \ Black \ Brown \ Gold \ Rose Gold
 Mounting : Surface Ceiling
 Can be customized to any size
 Housing Material : Aluminum Extruded & PC Cover.

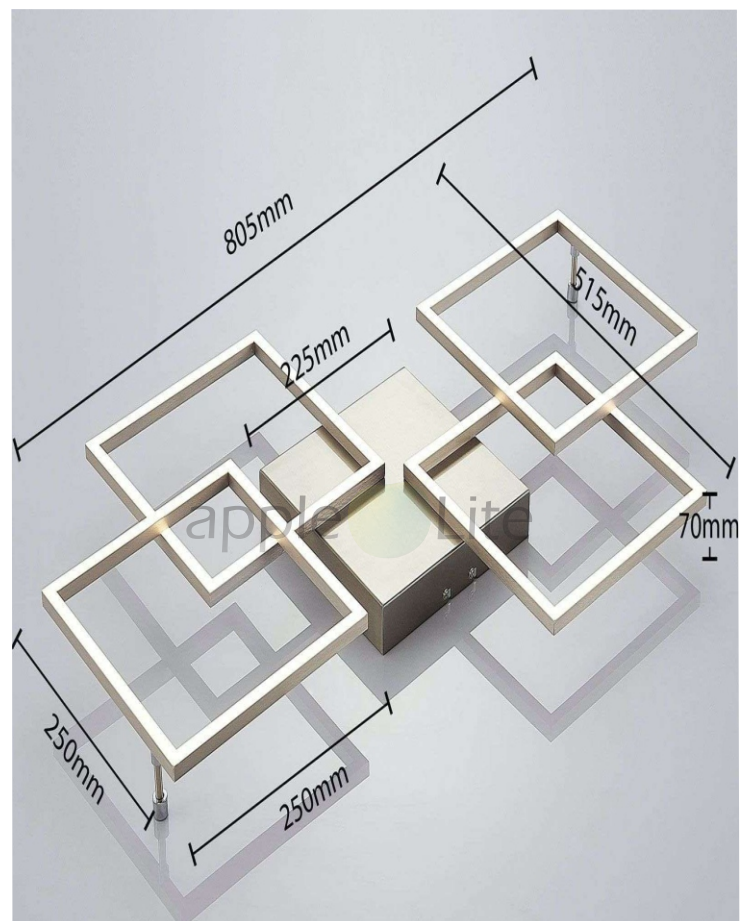

Product Code - KI-D306

Driver External : In Base
 Options : In Light
 Body Color : White \ Black \ Brown \ Gold \ Rose Gold
 Mounting : Surface Ceiling
 Can be customized to any size
 Housing Material : Aluminum Extruded & PC Cover.

Product Code	Profile Part	Watt	Color Temp.	Beam	CRI	Dimensions	MRP.
KI-D305	KISP06	50W	WW-NW-CW	120°	>80	600x750mm	14400.00
KI-D306	KISP06	50W	WW-NW-CW	120°	>80	750x750mm	14400.00

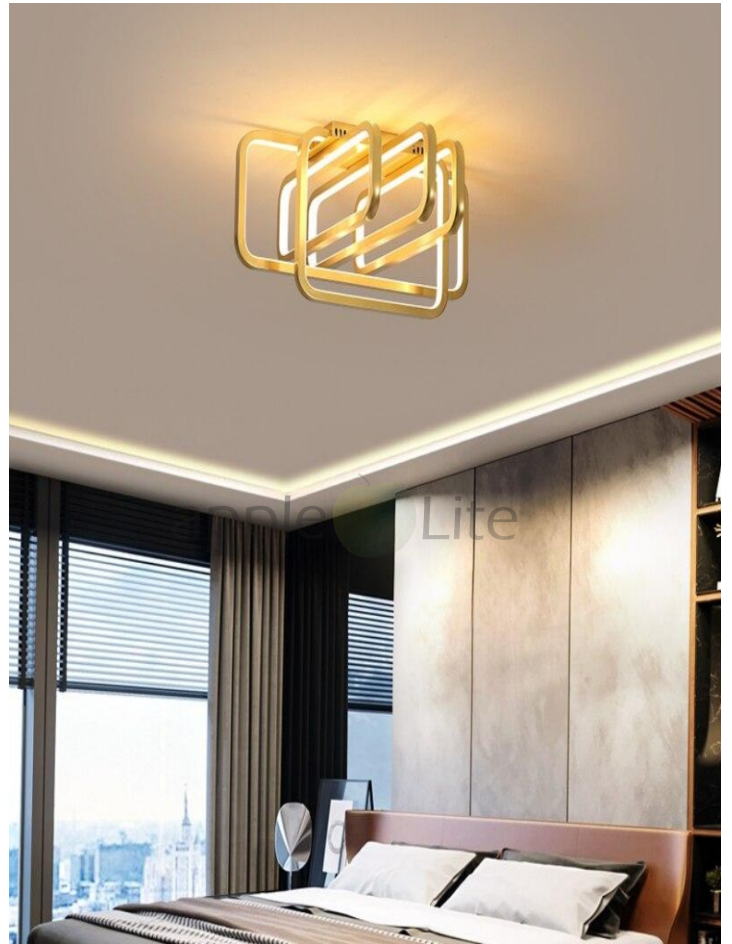

Product Code - KI-D307

Driver External : In Base
 Options : In Light
 Body Color : White \ Black\ Brown \ Gold \ Rose Gold
 Mounting : Surface Ceiling
 Can be customized to any size
 Housing Material : Aluminum Extruded & PC Cover.

Product Code - KI-D308

Driver External : In Base
 Options : In Light
 Body Color : White \ Black\ Brown \ Gold \ Rose Gold
 Mounting : Surface Ceiling
 Can be customized to any size
 Housing Material : Aluminum Extruded & PC Cover.

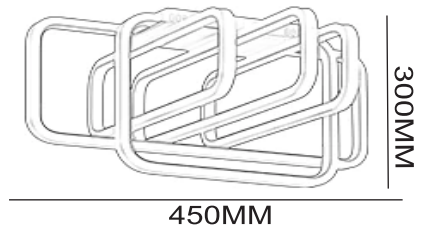
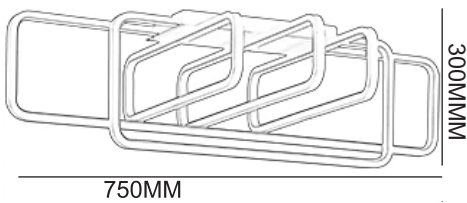

Product Code	Profile Part	Watt	Color Temp.	Beam	CRI	Dimensions	MRP.
KI-D307	KISP01	80W	WW-NW-CW	120°	>80	600x600mm	24400.00
KI-D308	KISP01	50W	WW-NW-CW	120°	>80	750x750mm	20200.00

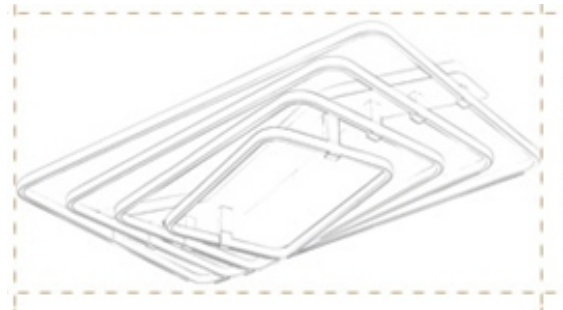
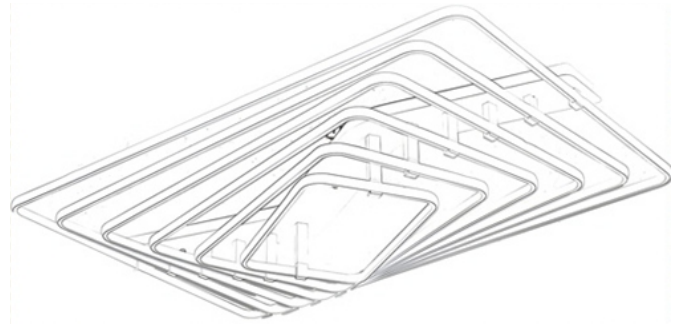

Product Code - **KI-D311**

Driver External : In Base

Options : Down + In Light

Body Color : White \ Black \ Brown \ Gold \ Rose Gold

Mounting : Surface Ceiling

Can be customized to any size

Housing Material : Aluminum Extruded & PC Cover.

Product Code	Profile Part	Watt	Color Temp.	Beam	CRI	Dimensions	MRP.
KI-D317-6(step)	KISP01	150W	WW-NW-CW	120°	>80	900x1200mm	72800.00
KI-D317-4(step)	KISP01	100W	WW-NW-CW	120°	>80	600x900mm	36800.00
KI-D317-2(step)	KISP01	50W	WW-NW-CW	120°	>80	300x600mm	12400.00

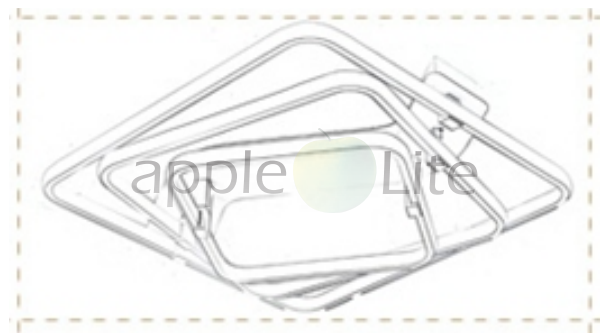
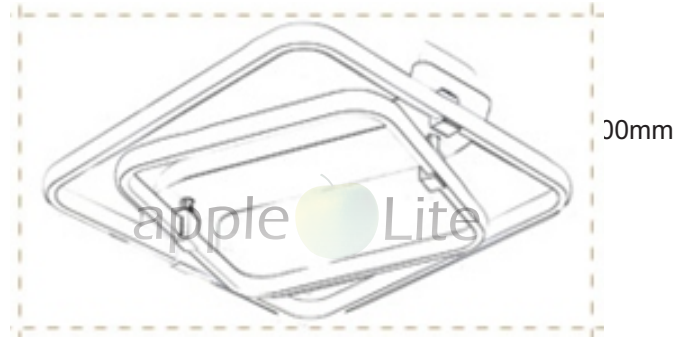

Product Code : KI-D318-3Step 500x500mm

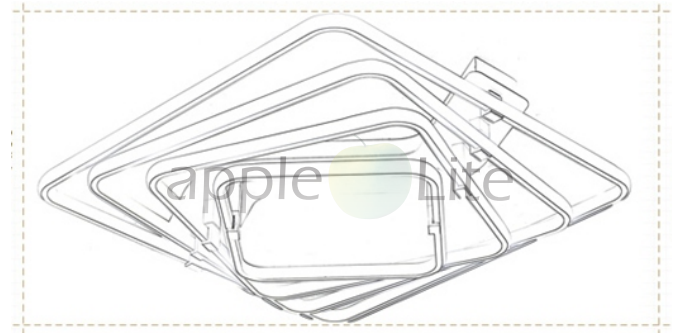

Product Code : KI-D318-4Step 600x600mm

Product Code - **KI-D311**

Driver External : In Base

Options : Down + In Light

Body Color : White \ Black \ Brown \ Gold \ Rose Gold

Mounting : Surface Ceiling

Can be customized to any size

Housing Material : Aluminum Extruded & PC Cover.

Product Code	Profile Part	Watt	Color Temp.	Beam	CRI	Dimensions	MRP.
KI-D318-2	KISP01	50W	WW-NW-CW	120°	>80	400x400mm	10100.00
KI-D318-3	KISP01	36W	WW-NW-CW	120°	>80	500x500mm	15500.00
KI-D318-4	KISP01	50W	WW-NW-CW	120°	>80	600x600mm	23400.00

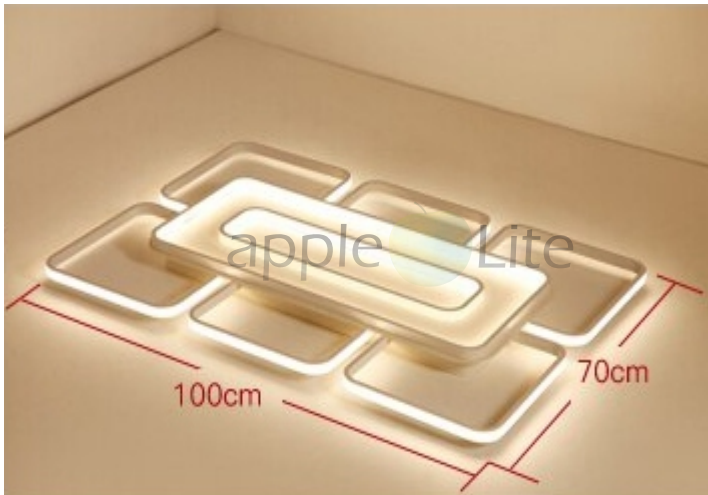

Product Code - **KI-D319-A**
 Driver External : In Base
 Options : Out + In Light
 Body Color : White \ Black\ Brown \ Gold \ Rose Gold
 Mounting : Surface Ceiling
 Can be customized to any size
 Housing Material : Aluminum Extruded & PC Cover.

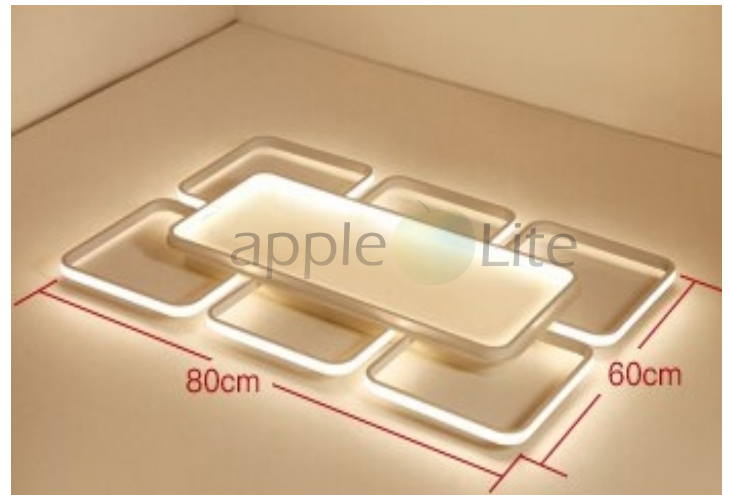

Product Code - **KI-D319-B**
 Driver External : In Base
 Options :Out + In Light
 Body Color : White \ Black\ Brown \ Gold \ Rose Gold
 Mounting : Surface Ceiling
 Can be customized to any size
 Housing Material : Aluminum Extruded & PC Cover.



Product Code - **KI-D319-C**
 Driver External : In Base
 Options : Out + In Light
 Body Color : White \ Black\ Brown \ Gold \ Rose Gold
 Mounting : Surface Ceiling
 Can be customized to any size
 Housing Material : Aluminum Extruded & PC Cover.

Product Code	Profile Part	Watt	Color Temp.	Beam	CRI	Dimensions	MRP.
KI-D319-A	KISP01	150W	WW-NW-CW	120°	>80	400x400mm	32800.00
KI-D319-B	KISP01	120W	WW-NW-CW	120°	>80	500x500mm	23800.00
KI-D319-C	KISP01	50W	WW-NW-CW	120°	>80	600x600mm	14600.00



Product Code - **KI-D320**

Driver External : In Base
 Options : Out + In Light
 Body Color : White \ Black \ Brown \ Gold \ Rose Gold
 Mounting : Surface Ceiling
 Can be customized to any size
 Housing Material : Aluminum Extruded & PC Cover.

Product Code - **KI-D321**

Driver External : In Base
 Options : Out + In Light
 Body Color : White \ Black \ Brown \ Gold \ Rose Gold
 Mounting : Surface Ceiling
 Can be customized to any size
 Housing Material : Aluminum Extruded & PC Cover.

Product Code	Profile Part	Watt	Color Temp.	Beam	CRI	Dimensions	MRP.
KI-D320	KISP01+S50	50W	WW-NW-CW	120°	>80	450x900mm	28000.00
KI-D321	KISP01	50W	WW-NW-CW	120°	>80	500x500mm	19800.00



Product Code - **KI-D322**

Driver External : In Base
 Options : Out + In Light
 Body Color : White \ Black\ Brown \ Gold \ Rose Gold
 Mounting : Surface Ceiling
 Can be customized to any size
 Housing Material : Aluminum Extruded & PC Cover.

Product Code - **KI-D323**

Driver External : In Base
 Options :Out + In Light
 Body Color : White \ Black\ Brown \ Gold \ Rose Gold
 Mounting : Surface Ceiling
 Can be customized to any size
 Housing Material : Aluminum Extruded & PC Cover.

Product Code	Profile Part	Watt	Color Temp.	Beam	CRI	Dimensions	MRP.
KI-D322	KISP01+S50	50W	WW-NW-CW	120°	>80	600x600mm	23800.00
KI-D323	KISP01+S50	80W	WW-NW-CW	120°	>80	600x600mm	21000.00

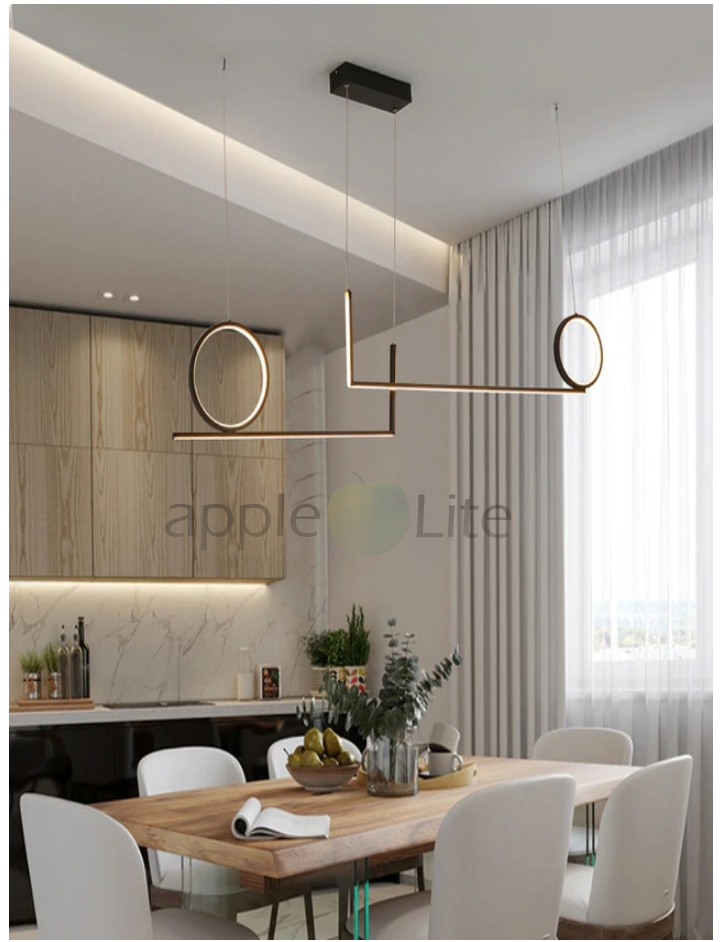
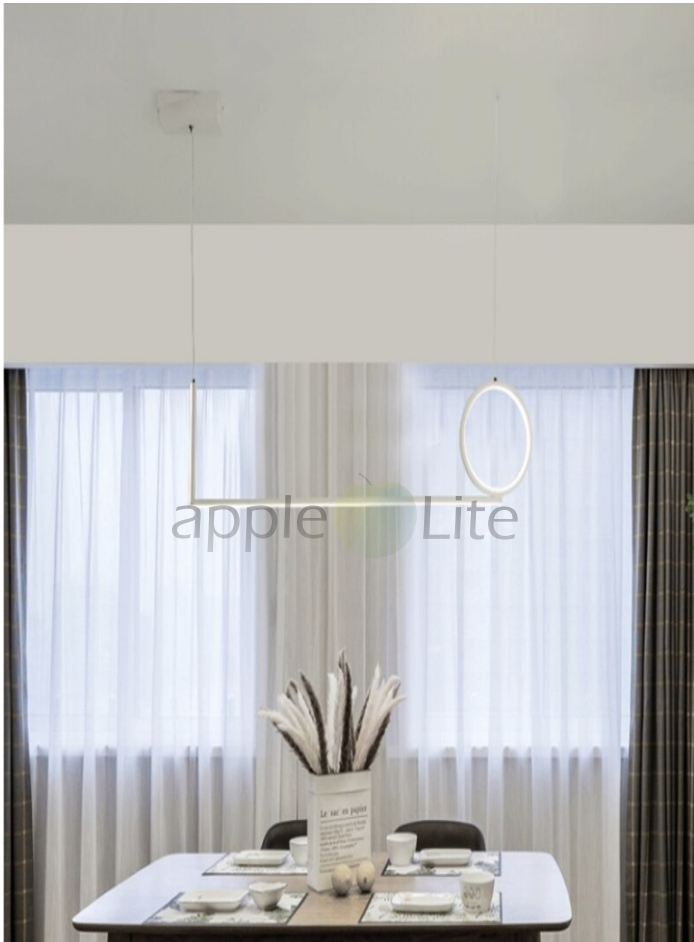

Product Code - **KI-D313-S**

Driver External : In Base
 Options : Out + In Light
 Body Color : White \ Black \ Brown \ Gold \ Rose Gold
 Mounting : Surface Ceiling
 Can be customized to any size
 Housing Material : Aluminum Extruded & PC Cover.

Product Code - **KI-D313-D**

Driver External : In Base
 Options :Out + In Light
 Body Color : White \ Black \ Brown \ Gold \ Rose Gold
 Mounting : Surface Ceiling
 Can be customized to any size
 Housing Material : Aluminum Extruded & PC Cover.

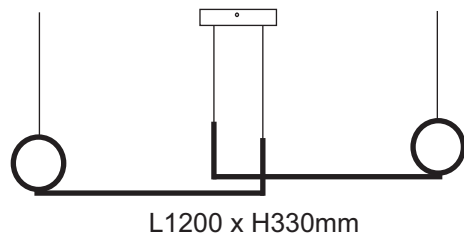
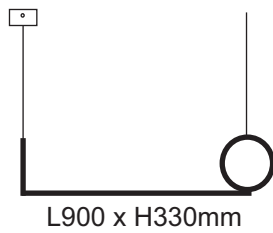

Product Code	Profile Part	Watt	Color Temp.	Beam	CRI	Dimensions	MRP.
KI-D313-S	KISP01	50W	WW-NW-CW	120°	>80	900x330mm	10100.00
KI-D313-D	KISP01	100W	WW-NW-CW	120°	>80	1200x330mm	20200.00



Product Code - **KI-D315**

Driver External : In Base
 Options : Out + In Light
 Body Color : White \ Black \ Brown \ Gold \ Rose Gold
 Mounting : Surface Ceiling
 Can be customized to any size
 Housing Material : Aluminum Extruded & PC Cover.



Product Code - **KI-D316**

Driver External : In Base
 Options : Out + In Light
 Body Color : White \ Black \ Brown \ Gold \ Rose Gold
 Mounting : Surface Ceiling
 Can be customized to any size
 Housing Material : Aluminum Extruded & PC Cover.

Product Code	Profile Part	Watt	Color Temp.	Beam	CRI	Dimensions	MRP.
KI-D315-S	KISP01	40W	WW-NW-CW	120°	>80	Dia. 450mm	10000.00
KI-D315-B	KISP01	60W	WW-NW-CW	120°	>80	Dia. 600mm	12000.00
KI-D316	KISP01	80W	WW-NW-CW	120°	>80	Dia. 600mm	21000.00

Wall Light



Product Code - **KI-D213**
 Body Color : White \ Black\ Brown \ Gold \ Rose Gold
 Can be customized to any size
 Housing Material : Aluminum Extruded & PC Cover.



Product Code - **KI-D133**
 Body Color : White \ Black\ Brown \ Gold \ Rose Gold
 Can be customized to any size
 Housing Material : Aluminum Extruded & PC Cover.



Product Code - **KI-D134**
 Body Color : White \ Black\ Brown \ Gold \ Rose Gold
 Can be customized to any size
 Housing Material : Aluminum Extruded & PC Cover.



Product Code - **KI-D135**
 Body Color : White \ Black\ Brown \ Gold \ Rose Gold
 Can be customized to any size
 Housing Material : Aluminum Extruded & PC Cover.

Product Code	Profile Part	Watt	Color Temp.	Beam	CRI	Dimensions	MRP.
KI-D213	KISP01	12W	WW-NW-CW	120°	>80	200mm	2700.00
KI-D213	KISP01	16W	WW-NW-CW	120°	>80	300mm	4030.00
KI-D133-C	KISP01	8W	WW-NW-CW	120°	>80	300mm	1010.00
KI-D133-C	KISP01	12W	WW-NW-CW	120°	>80	600mm	2020.00
KI-D134-S	KISP01	8W	WW-NW-CW	120°	>80	300mm	910.00
KI-D134-S	KISP01	12W	WW-NW-CW	120°	>80	600mm	1820.00
KI-D135	KISP06	8W	WW-NW-CW	120°	>80	300mm	1210.00
KI-D135	KISP06	12W	WW-NW-CW	120°	>80	600mm	2420.00



Product Code - **KI-D140**
 Body Color : White \ Black\ Brown \ Gold \ Rose Gold
 Can be customized to any size
 Housing Material : Aluminum Extruded & PC Cover.



Product Code - **KI-D141**
 Body Color : White \ Black\ Brown \ Gold \ Rose Gold
 Can be customized to any size
 Housing Material : Aluminum Extruded & PC Cover.



Product Code - **KI-D142**
 Body Color : White \ Black\ Brown \ Gold \ Rose Gold
 Can be customized to any size
 Housing Material : Aluminum Extruded & PC Cover.

Product Code	Profile Part	Watt	Color Temp.	Beam	CRI	Dimensions	MRP.
KI-D140	KISP01	16W	WW-NW-CW	120°	>80	300mm	1240.00
KI-D140	KISP01	24W	WW-NW-CW	120°	>80	450mm	1850.00
KI-D141	KISP05	8W	WW-NW-CW	120°	>80	300mm	785.00
KI-D141	KISP05	12W	WW-NW-CW	120°	>80	450mm	1570.00
KI-D142	KIS35	8W	WW-NW-CW	120°	>80	300mm	4930.00
KI-D142	KIS35	12W	WW-NW-CW	120°	>80	450mm	5800.00



Product Code - **KI-D200-D**

Driver External

Options : Out Light \ In Light \ Partial Light

Body Color : White \ Black \ Brown \ Gold \ Rose Gold

Mounting : Hanging Length 1000mm.

Can be customized to any size

Housing Material : Aluminum Extruded & PC Cover.

Product Code - **KI-D200-W**

Driver External

Options : Out Light \ In Light \ Partial Light

Body Color : White \ Black \ Brown \ Gold \ Rose Gold

Mounting : Hanging Length 1000mm.

Can be customized to any size

Housing Material : Aluminum Extruded & PC Cover.

Product Code	Profile Part	Watt	Color Temp.	Beam	CRI	Dimensions	MRP.
KI-D200-D	KISP01	16W	WW-NW-CW	120°	>80	300mm	4200.00
KI-D200-D	KISP01	24W	WW-NW-CW	120°	>80	450mm	6000.00
KI-D200-W	KISP01	32W	WW-NW-CW	120°	>80	300mm	4200.00
KI-D200-W	KISP01	40W	WW-NW-CW	120°	>80	450mm	6000.00
KI-D200-W	KISP01	48W	WW-NW-CW	120°	>80	600mm	8300.00



Product Code - **KI-D224**

Options : Out Light \ In Light \ Partial Light
 Body Color : White \ Black \ Brown \ Gold \ Rose Gold
 Mounting : Hanging Length 1000mm.
 Can be customized to any size
 Housing Material : Aluminum Extruded & PC Cover.



Product Code - **KI-D225**

Driver External - adaptor type
 Options : Out Light \ In Light \ Partial Light
 Body Color : White \ Black \ Brown \ Gold \ Rose Gold
 Mounting : Hanging Length 1000mm.
 Can be customized to any size
 Housing Material : Aluminum Extruded & PC Cover.

Product Code	Profile Part	Watt	Color Temp.	Beam	CRI	Dimensions	MRP.
KI-D224	KISP01	2W	WW-NW-CW	120°	>80	300mm	2020.00
KI-D225	KISP01	12W	WW-NW-CW	120°	>80	450mm	3400.00

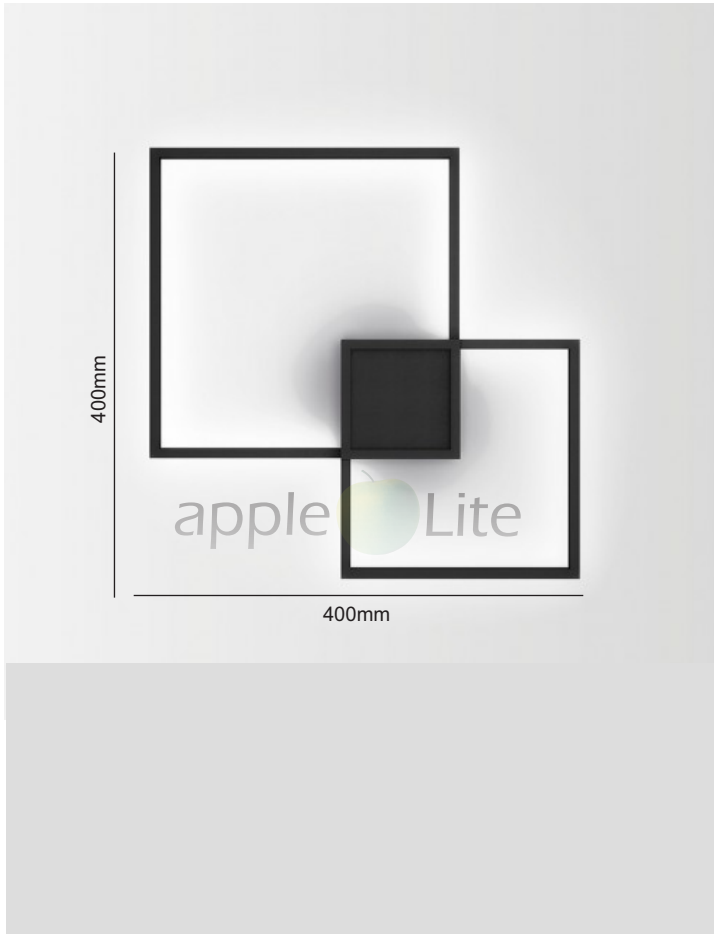

Product Code - KI-D150-BL

Driver External : : In Base
 Options : Back Light
 Body Color : White \ Black \ Brown \ Gold \ Rose Gold
 Mounting : Wall
 Can be customized to any size
 Housing Material : Aluminum Extruded & PC Cover.

Product Code - KI-D227-IL

Driver External : Adaptor Type
 Options : In Light
 Body Color : White \ Black \ Brown \ Gold \ Rose Gold
 Mounting : Floor
 Can be customized to any size
 Housing Material : Aluminum Extruded & PC Cover.

Product Code	Profile Part	Watt	Color Temp.	Beam	CRI	Dimensions	MRP.
KI-D150-BL	KISP01	32W	WW-NW-CW	120°	>80	400x400mm	7180.00
KI-D227-IL	KISP01	64W	WW-NW-CW	120°	>80	1000mm	12200.00



Product Code - **KI-D1211**
Housing Material : Wood.

Product Code - **KI-D1202**
Holder Base - E27Housing
Material : Wood+Rope

Product Code	Profile Part	Watt	Beam	Dimensions	MRP.
KI-D1211	Wood	NA		Dia.380x450mm	40000.00
KI-D1202	Wood	6xE27		1200mm	20200.00

apple  Lite

Let there be light

